

**2001 AAPM Summer School
Seattle, Washington**

ACR R/F Phantom

Charles R. Wilson, Ph.D., FACR

Medical College of Wisconsin

Milwaukee, Wisconsin



ACR R/F Phantom

- This lecture has been approved for 1 hour of continuing medical physics education credits by CAMPEC.
- This lecture also has pending FDA approval for the treatment of a common condition affecting many individuals in the US.
- This condition will be named for those still awake at the end of this talk.

INSOMNIA !

R/F Physics Subcommittee

Name - Call Name

Robert Dixon - Captain Midnight

Beth Schueler - Wonder Woman

Charles Wilson - Obiwon Kenobi

Pam Wilcox - Xena Warrior Princess

Penny Butler - Goldilocks

Krista Bush - Buffy the Vampire Slayer

Prototype Chest Accreditation Phantom

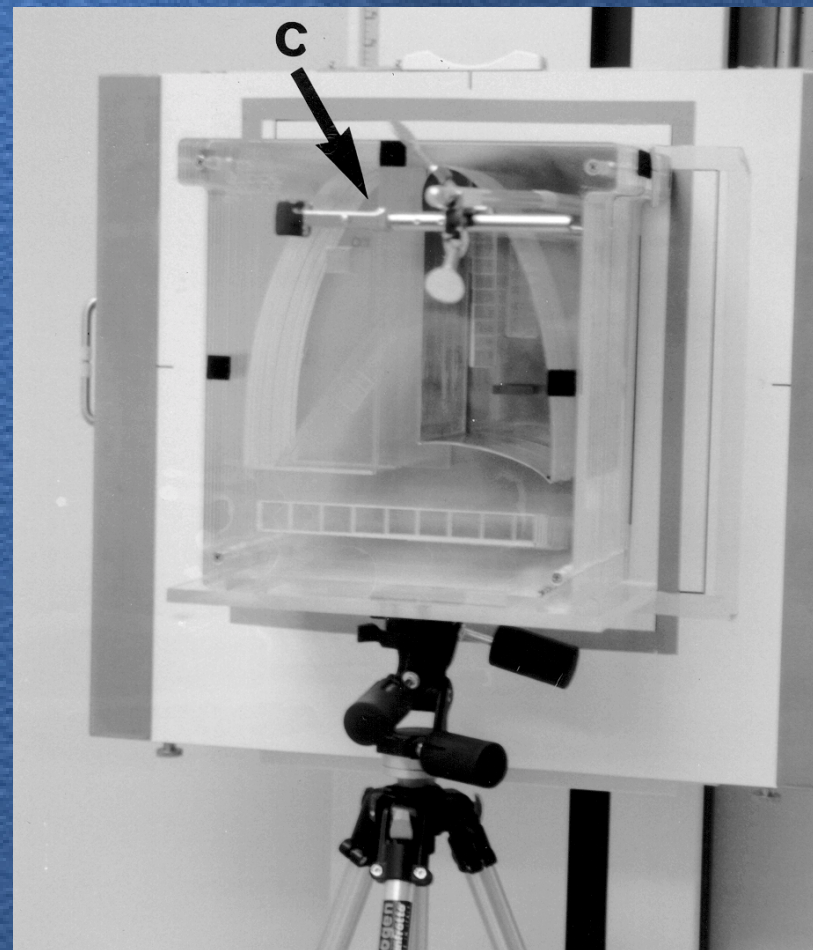

Resting in Peace

R/F Phantom Design Criteria

- Radiographically tissue equivalent
 - PMMA and aluminum
 - weight: 12 to 30 pounds
- Build on existing, widely used phantoms
 - CDRH chest and abdomen NEXT phantoms
- Modular design
 - chest, abdomen and interventional programs
- Inexpensive and easy to interpret

CDRH NEXT Abdomen Phantom

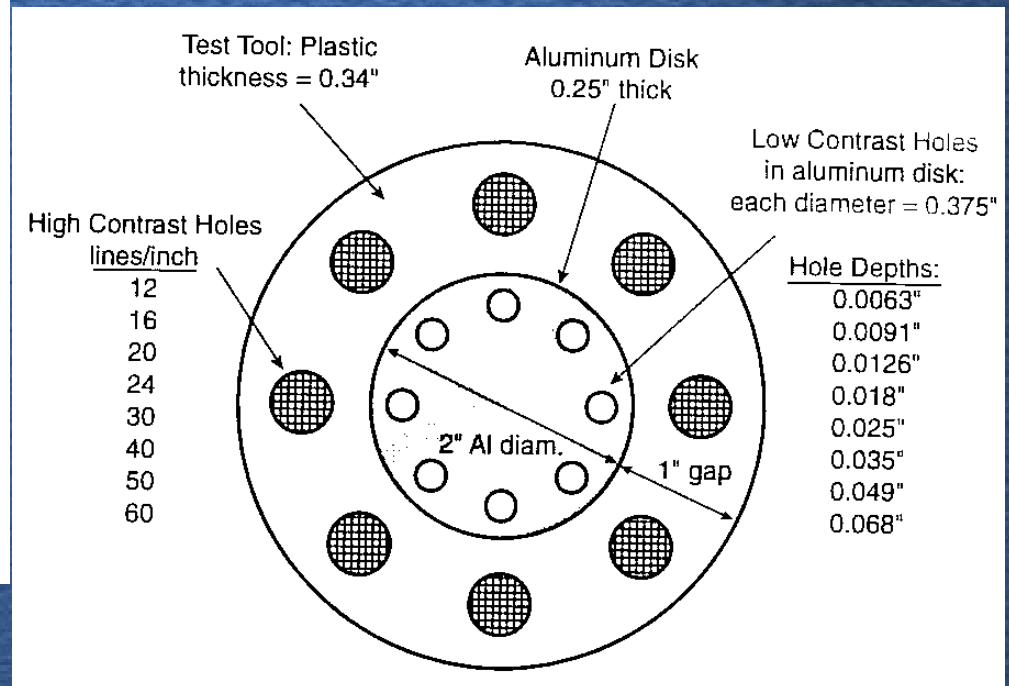
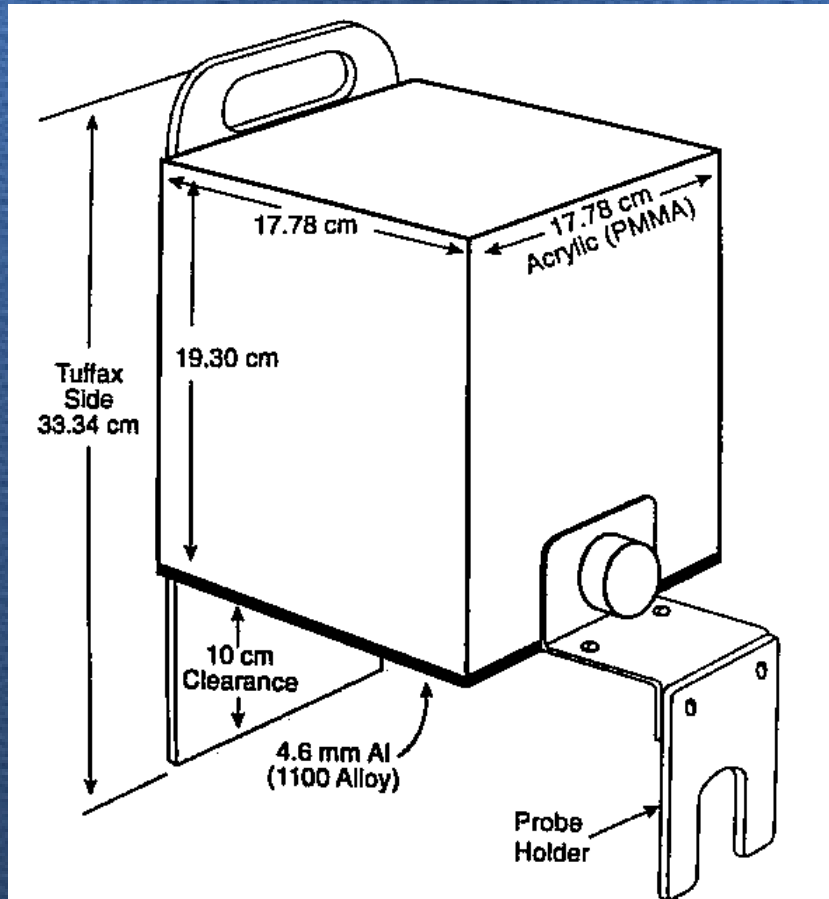

CDRH Chest Phantom

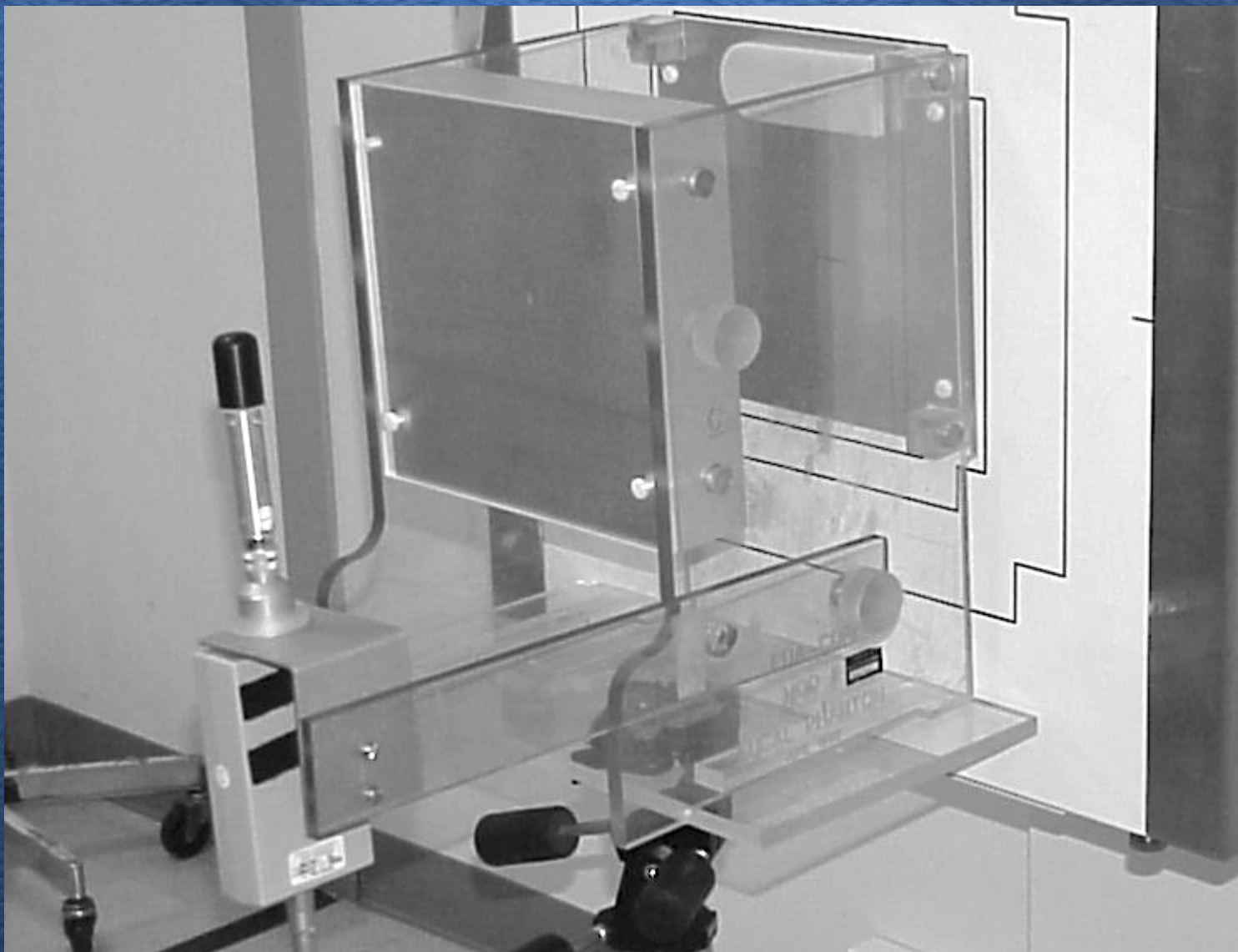

ACR R/F Phantom Components

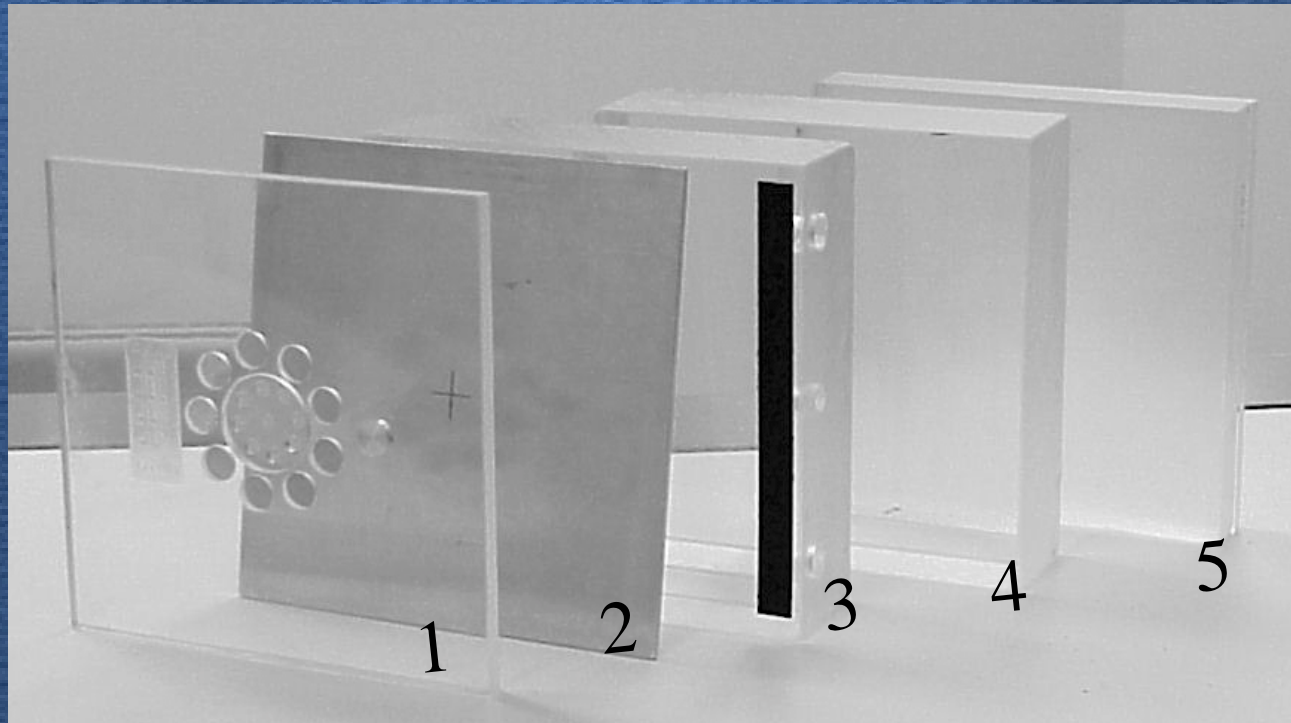

1. Test object plate (1 cm PMMA)
2. Aluminum plate (3/16")
3. PMMA block (7.6 cm)
4. PMMA block (7.6 cm)
5. PMMA block (4.1 cm)

ACR Chest Phantom

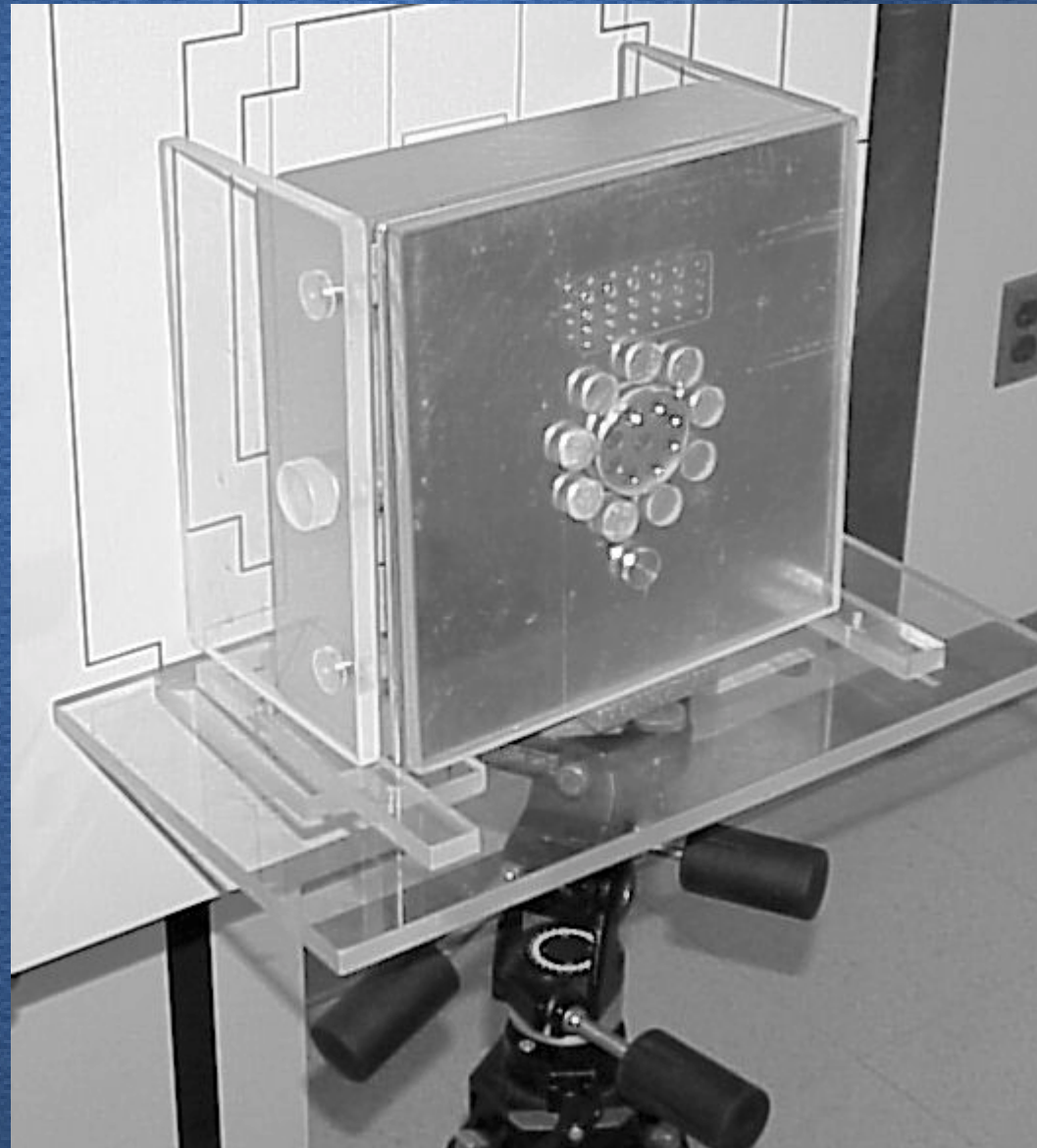

**Chest
(horizontal
tube)**

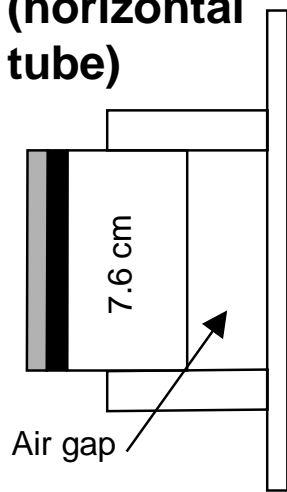

ACR Abdomen Phantom

**Abdomen
(overtable
tube)**

7.6 cm
7.6 cm
4.1 cm



ACR R/F Test Objects

A. Contrast Detail Pattern

- 4 rows – 6 columns

B. Copper mesh

- 9 patterns

C. Central aluminum disk

- 9 low contrast objects

D. Aluminum disk

- Latitude test

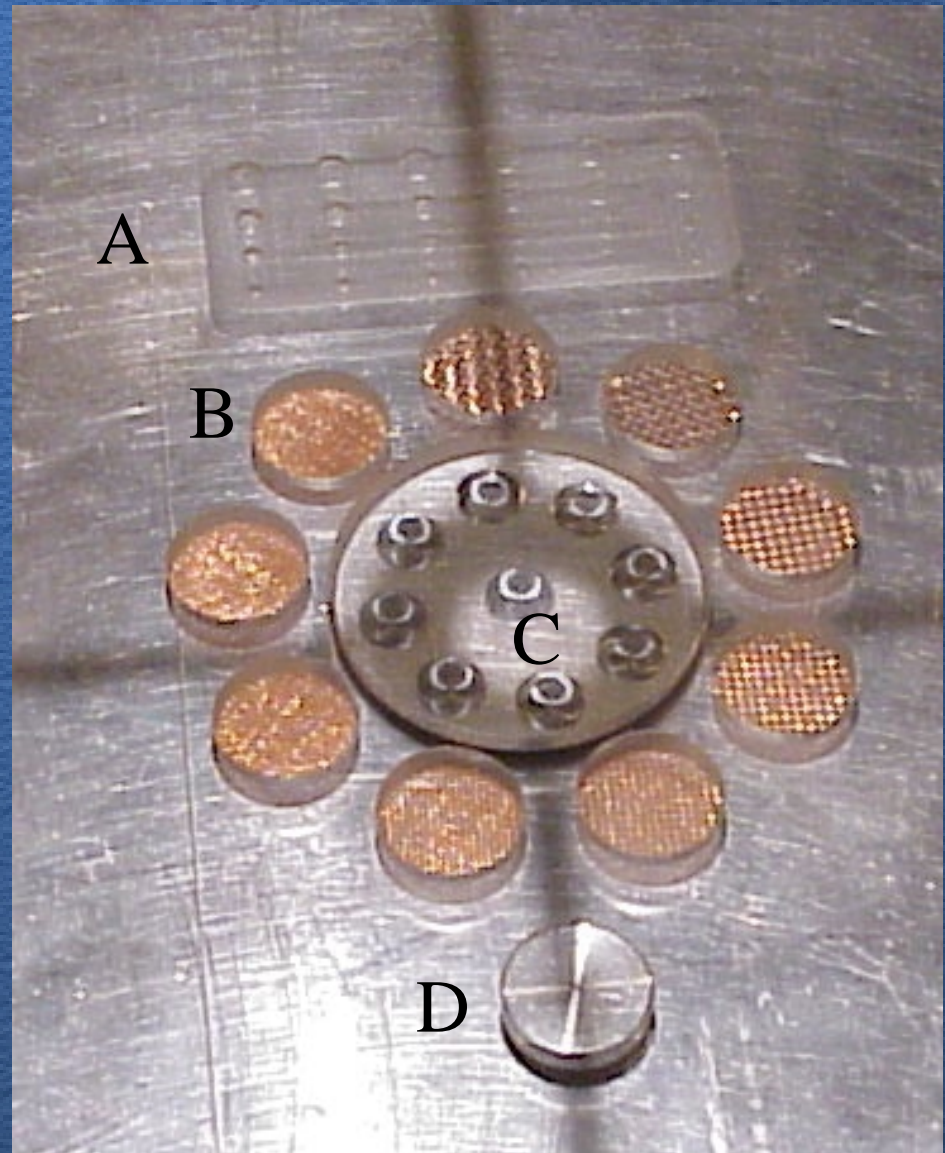

Phantom Image Evaluation Suggested Criteria (1)

- High Contrast Mesh
 - Chest – 8 or better
 - Abdomen – 7 or better
 - Spot film – 5 or better
- Central Aluminum Disk
 - Chest – 7 or better
 - Abdomen – 7 or better
 - Spot film – 6 or better

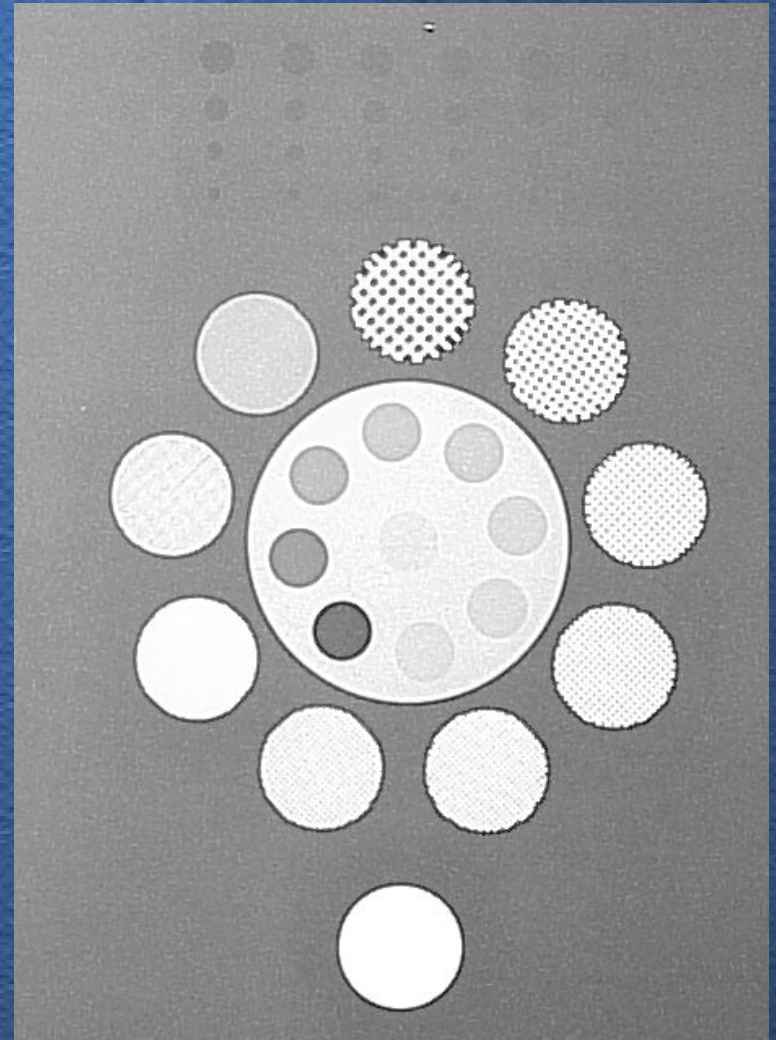

Phantom Image Evaluation Suggested Criteria (2)

- Contrast Detail
 - Columns from left
 - 4 / 4 / 3 / 2
- Optical Density
 - Chest – 1.3 to 1.6
 - Abdomen – 1.3 to 1.6
 - Spot film – 1.0 to 1.8
- Latitude Disk
 - To be established

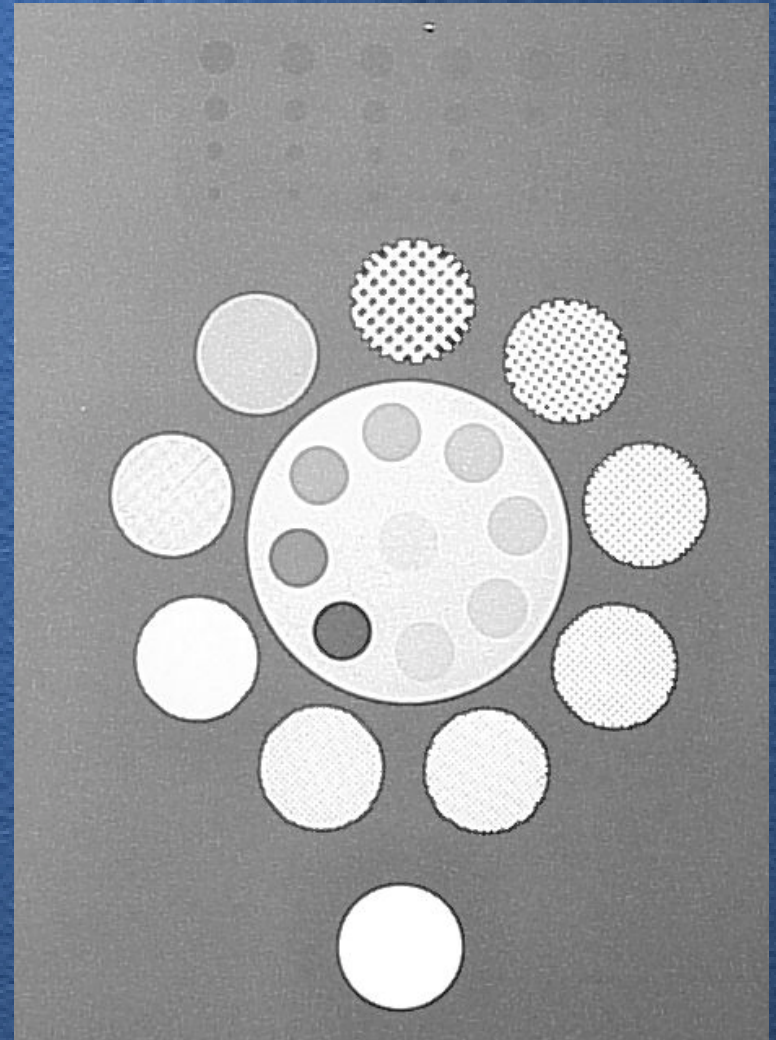

Contrast Detail Test Object

Contrast_{Subject} (~%)

3.0 2.6 2.0 1.5 1.0 0.8

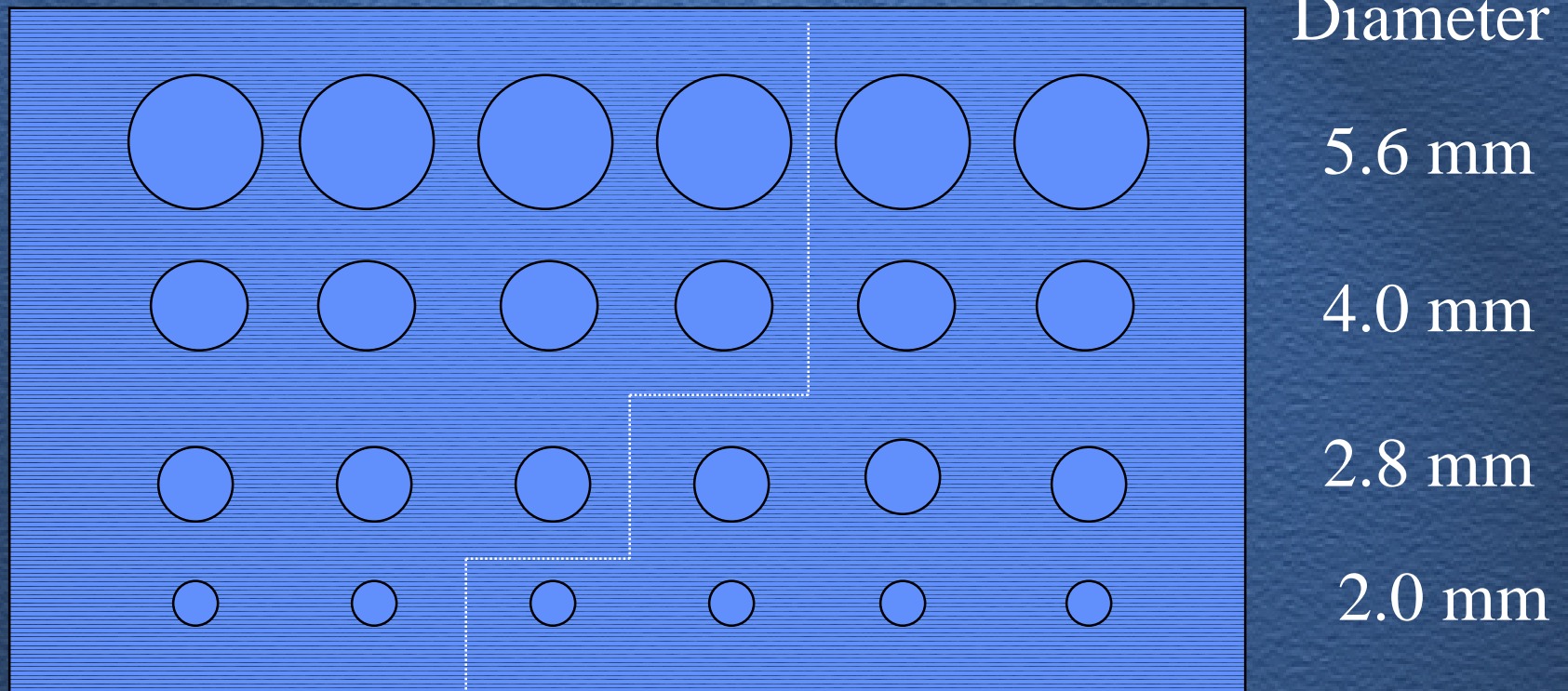

Suggested performance standard :

All objects to the left of the dotted line are to be visible.

Phantom Transmission Test Geometries

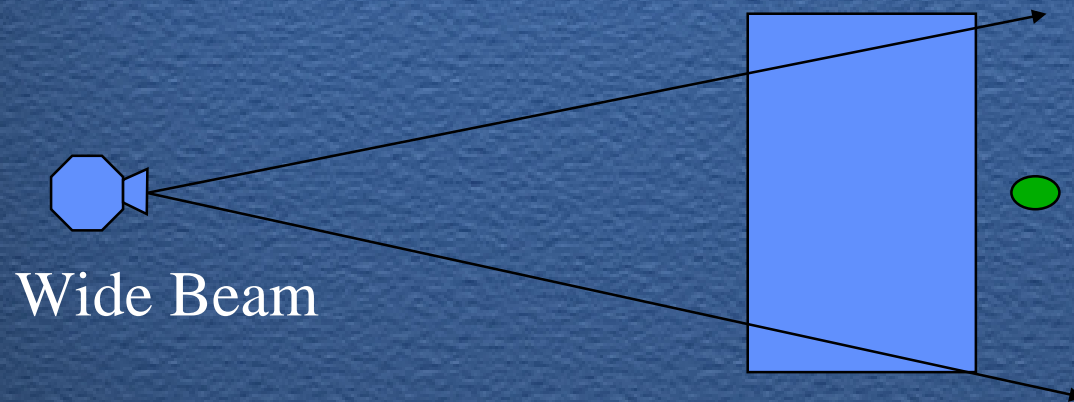
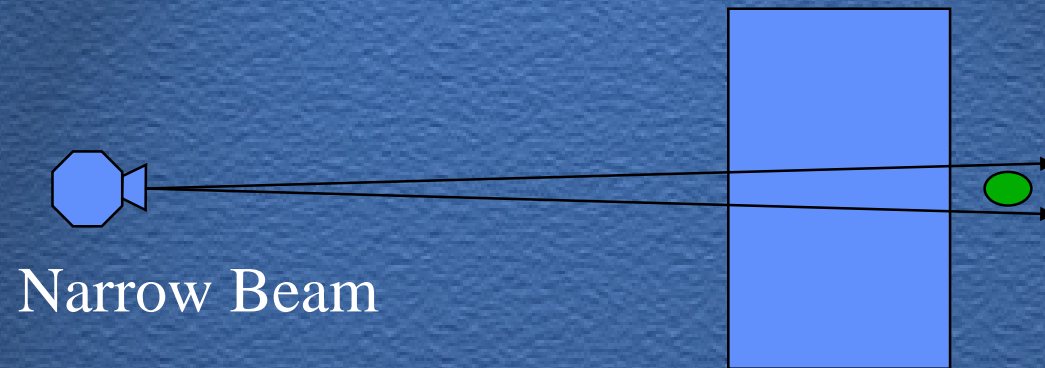

Narrow Beam % Transmission CDRH and ACR Chest Phantoms

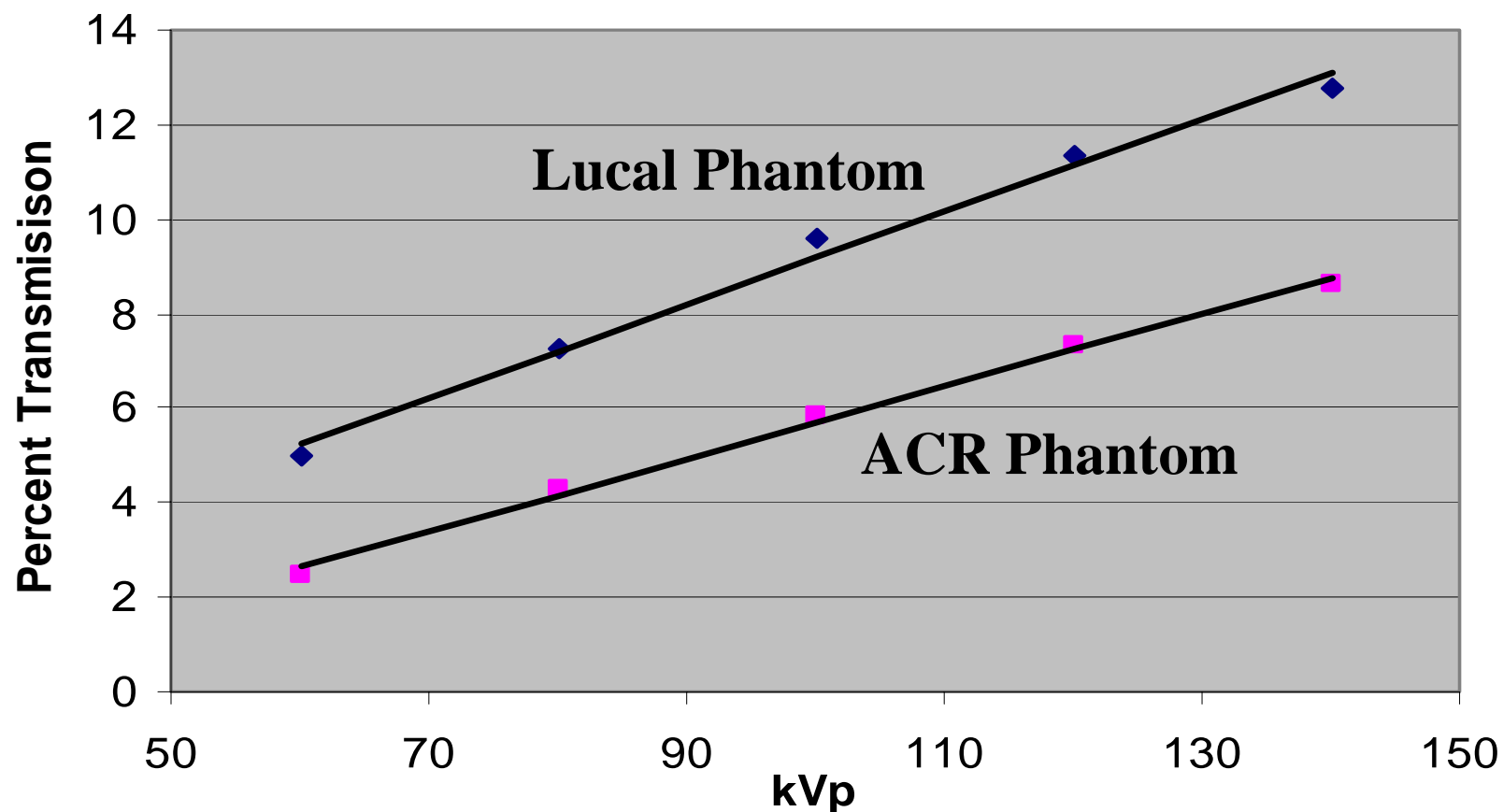

ACR ~ 2.5 cm more PMMA

Scatter to Primary Ratio CDRH and ACR Chest Phantoms

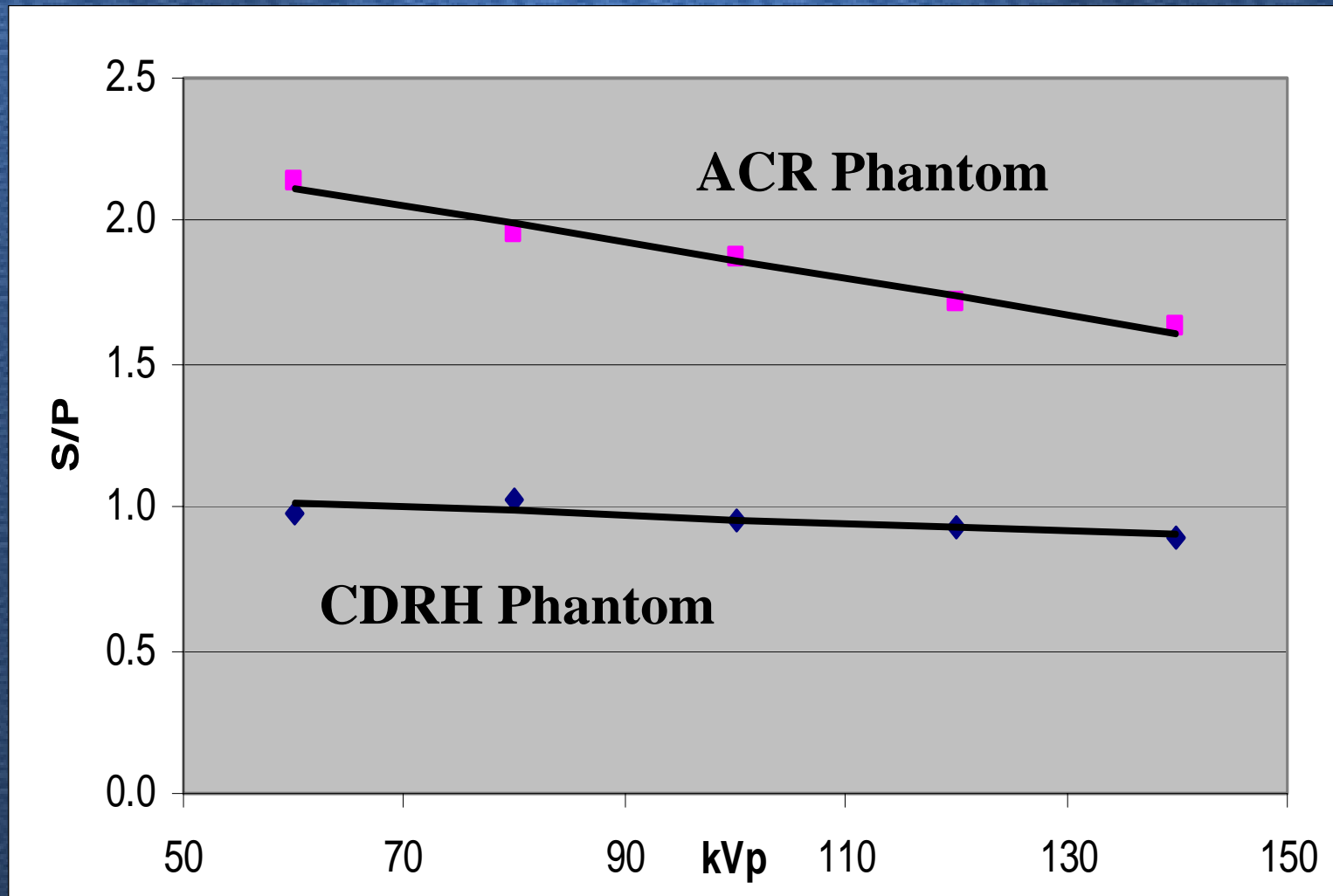

Wide Beam % Transmission CDRH and ACR Chest Phantoms

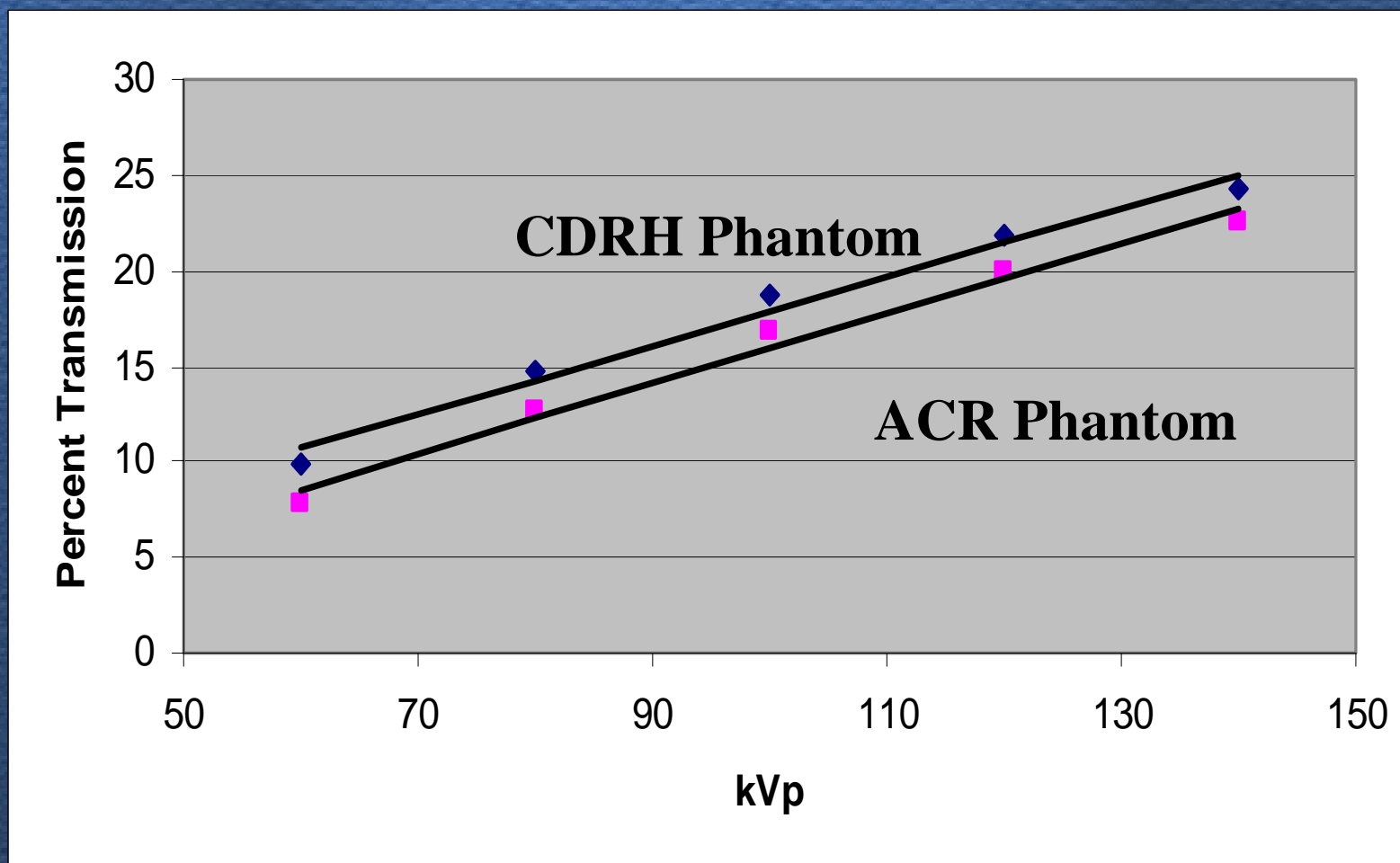

ACR: Air gap ~ 9 cm less

Technique Factors (GE DR unit at 120 kVp)

- ACR – Chest Phantom
 - 2.5 mAs (0.126 mGy)
- CDRH Chest Phantom
 - 2.04 mAs (0.103 mGy)

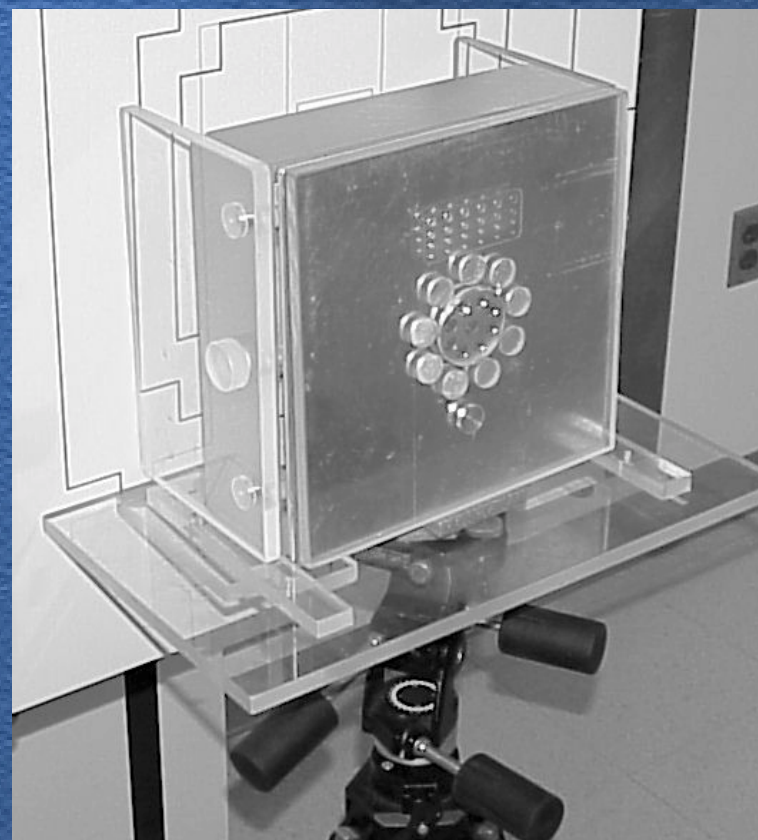

Technique Factor Comparison (GE DR unit at 120 kVp)

- ACR – Chest Phantom
 - 2.5 mAs (0.126 mGy)
- 16 consecutive male patients
 - Averages: 201 lbs, 3.2 mAs, 0.16 mGy
- 18 consecutive female patients
 - Averages: 173 lbs, 2.5 mAs, 0.126 mGy

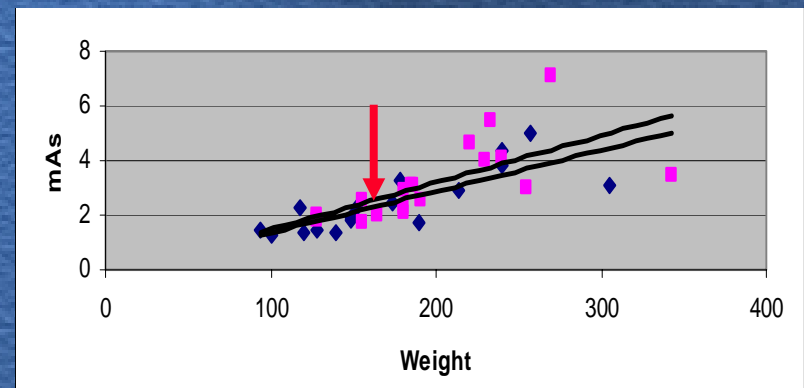

ACR Chest Phantom equivalent to ~ 170 lb man or woman

CDRH and ACR Abdomen Phantoms

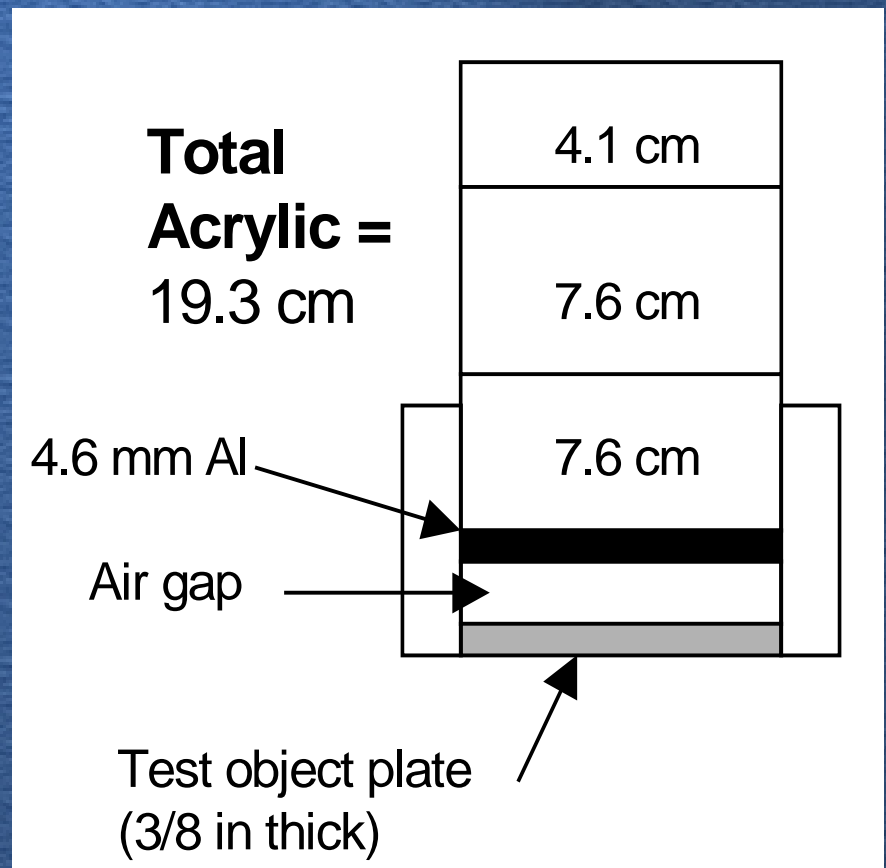
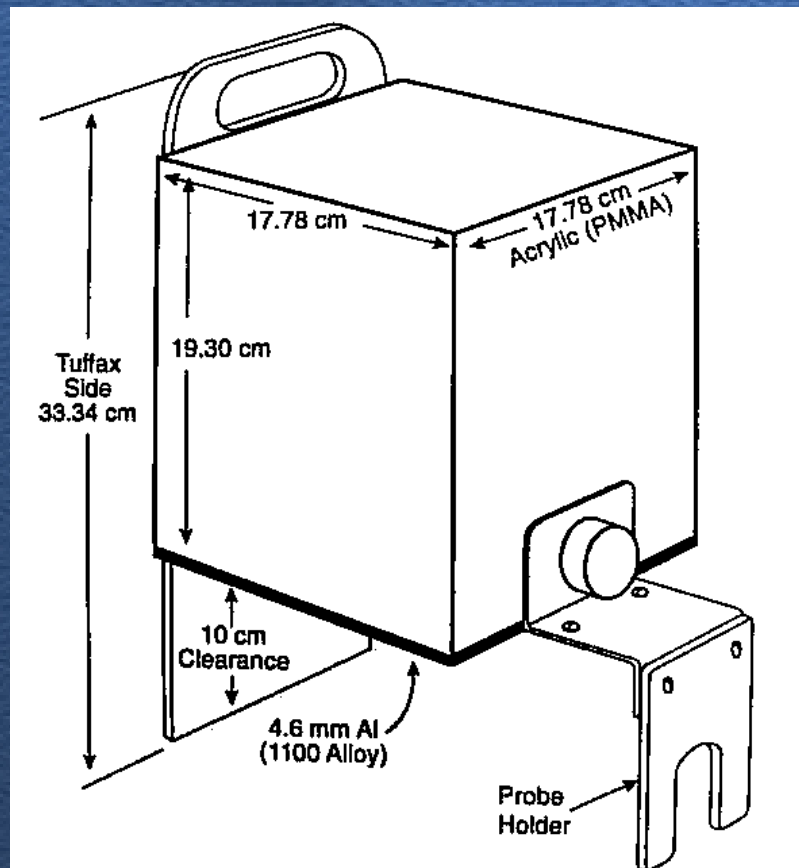

Narrow Beam % Transmission CDRH and ACR Abdomen Phantoms

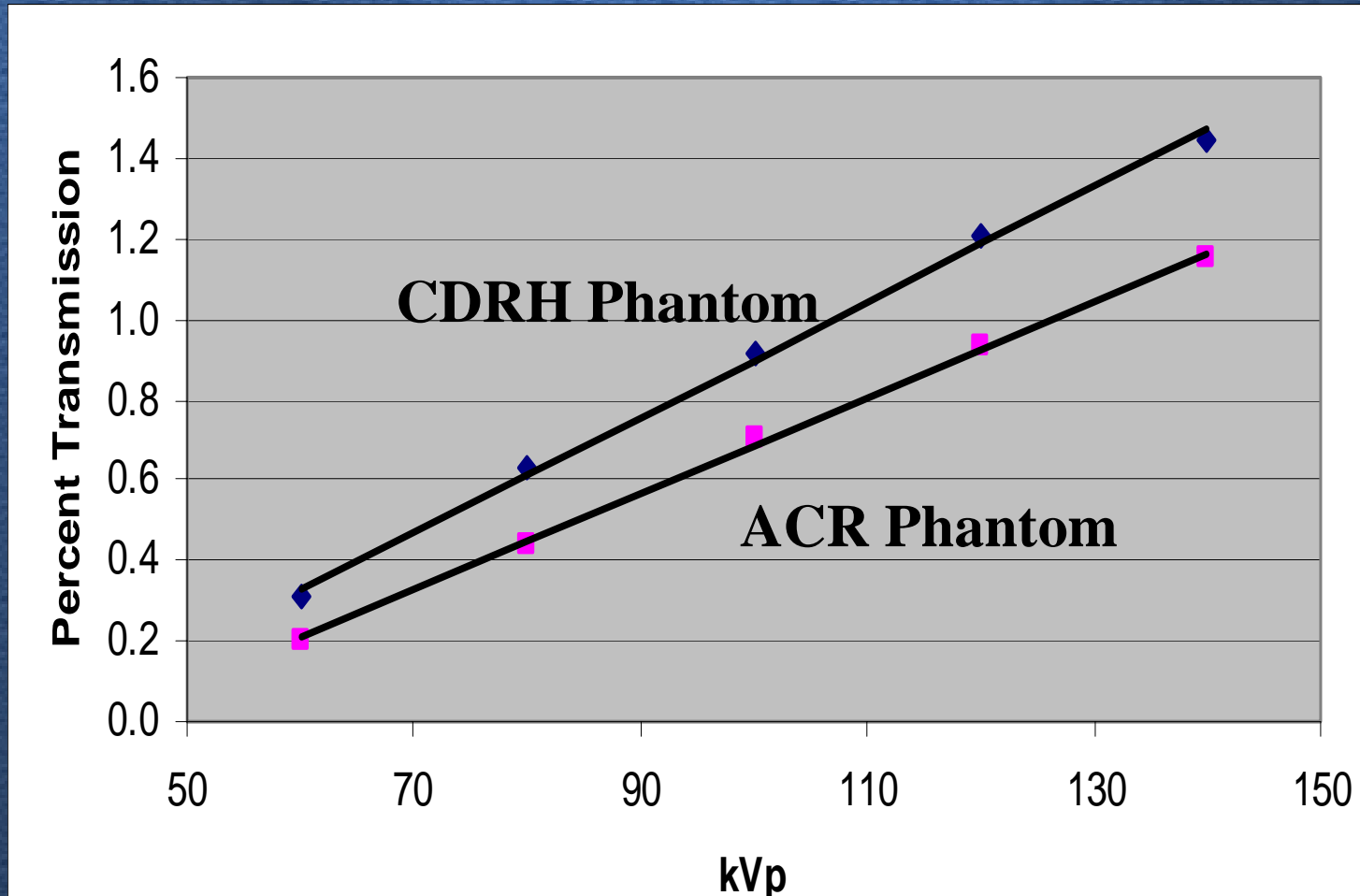

Entrance Skin Air Kerma Dosimeter

- Desirable Characteristics
 - Precise
 - Energy independent response
 - Linear response with air kerma
 - Accurate
- Choices
 - Thermoluminescent Dosimeter (TLD)
 - Optical Stimulated Luminescence (OSL)

Luxel Personnel Dosimeter

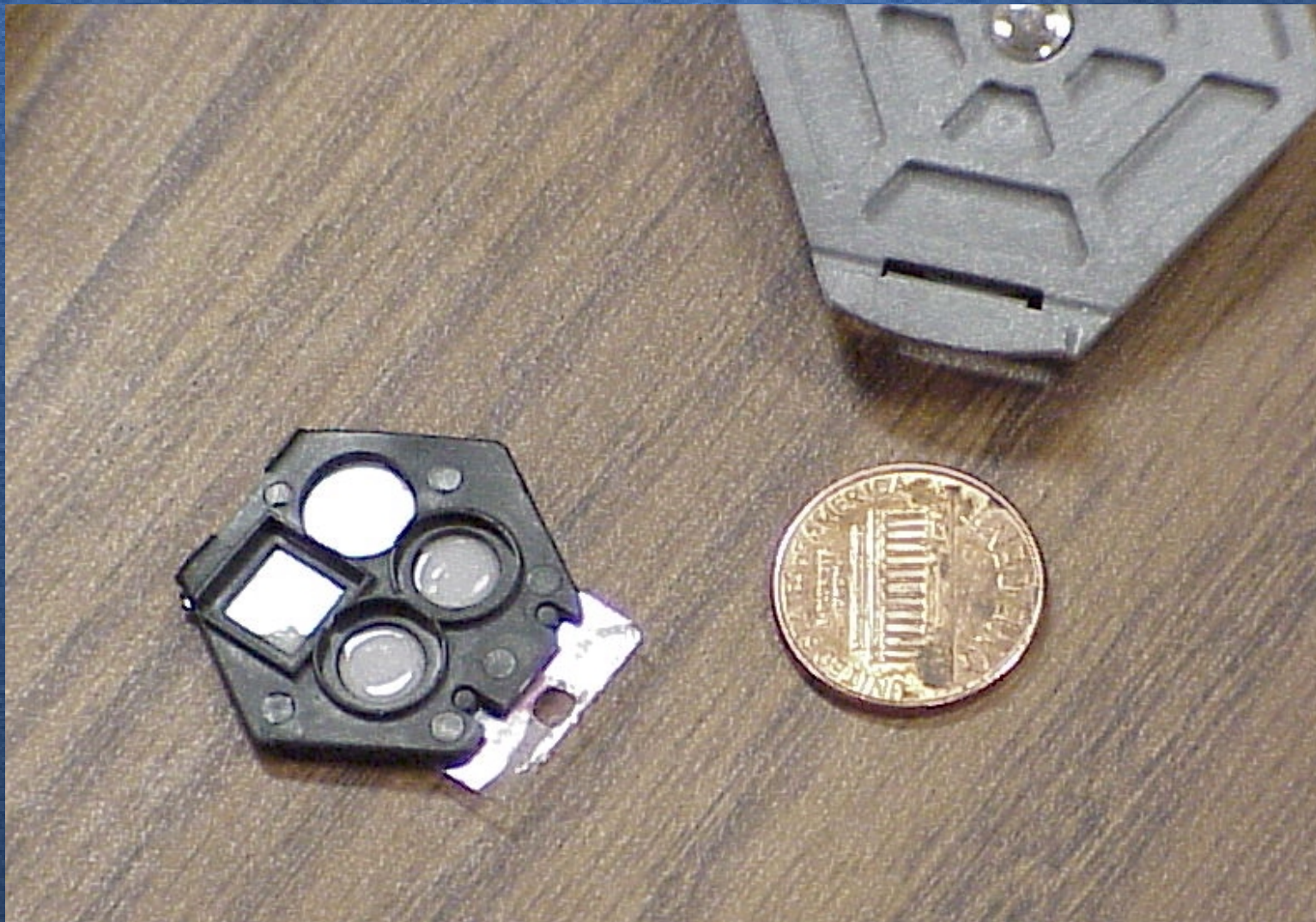

Preliminary Tests of Luxel Personnel Dosimeter

- Energy response
 - Dosimeter pairs irradiated using different hvl beams
 - 0.32, 0.67, 2.2, 4.2, 5.1 and 6.0 (mm Al)

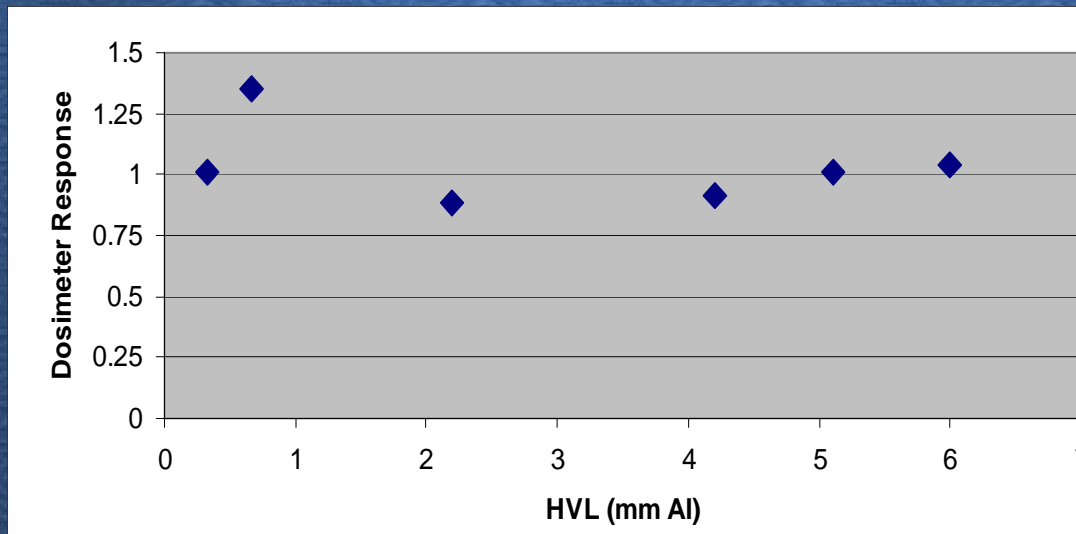

- Exposure response linear from 4 to 900 mR
- Precision acceptable: ~ 10% @ 10 mR
> 3% @ 100 mR

Optical Stimulated Luminescence OSL

- Illuminate an irradiated crystal (Al_2O_3) with a given wavelength of light to initiate the movement of charge from trap sites to luminescence centers.
- Amount of luminescence is proportion to dose and amount of illumination (optical energy) imparted to the crystal.

Conceptual Energy Diagram Following Irradiation

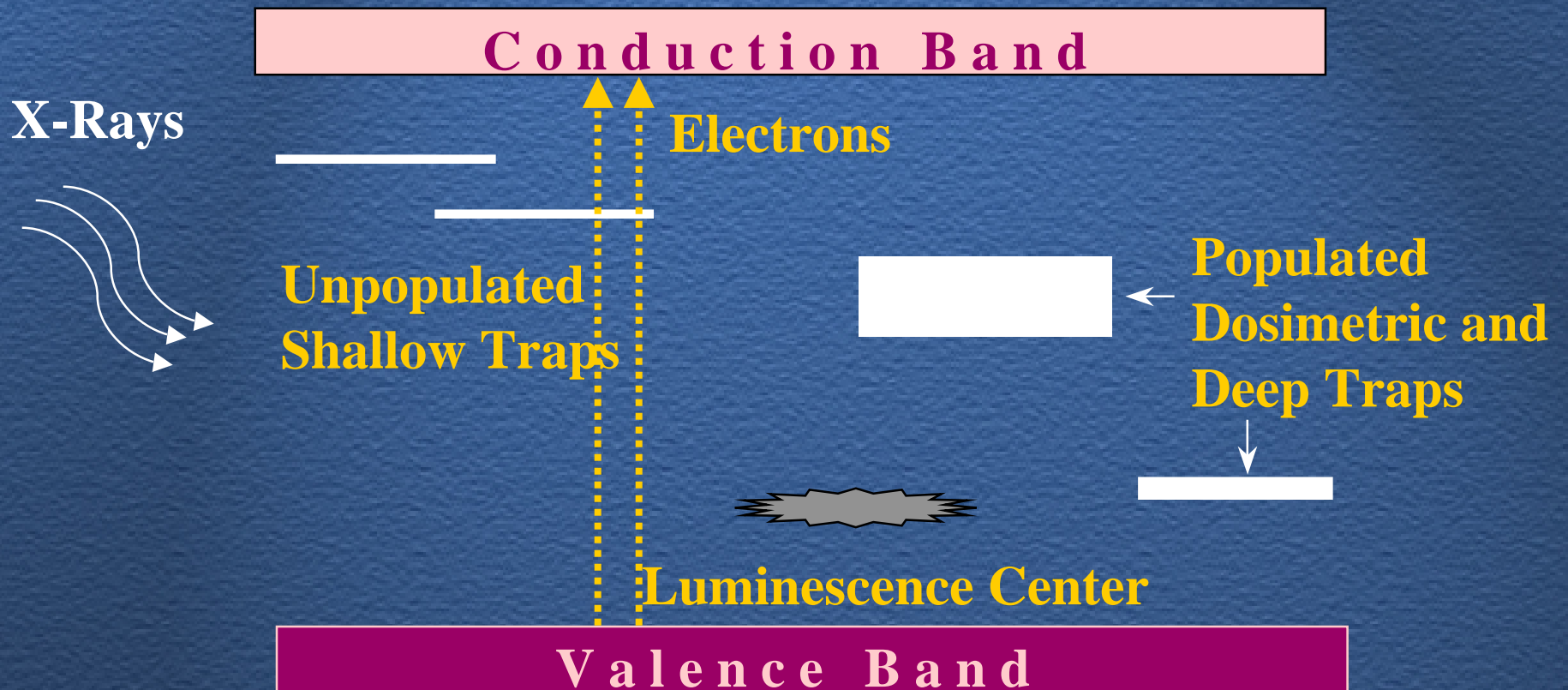

Conceptual Energy Diagram

Delayed and Pulsed OSL Stimulation

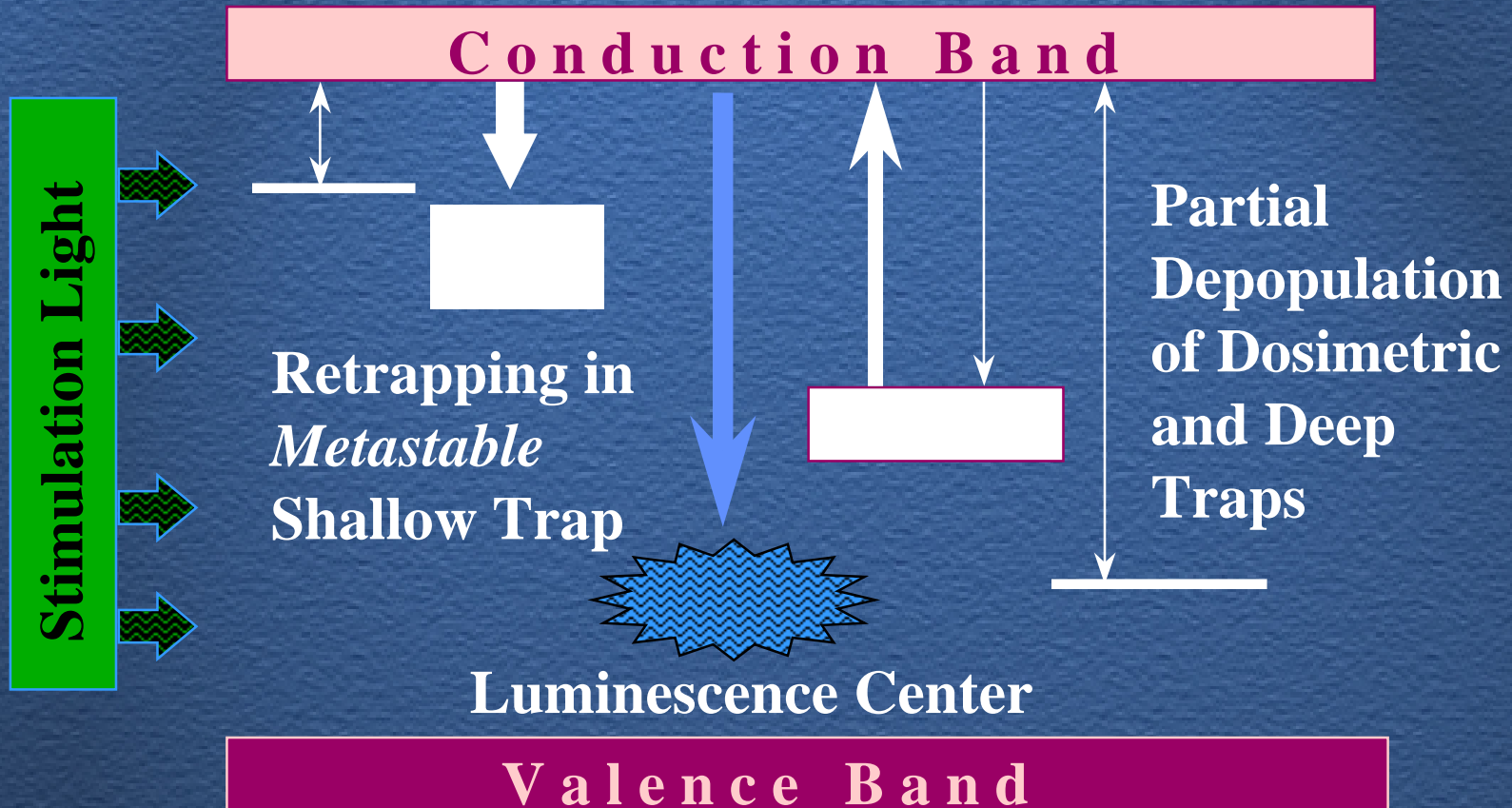

Luxel Dosimeter with Filter

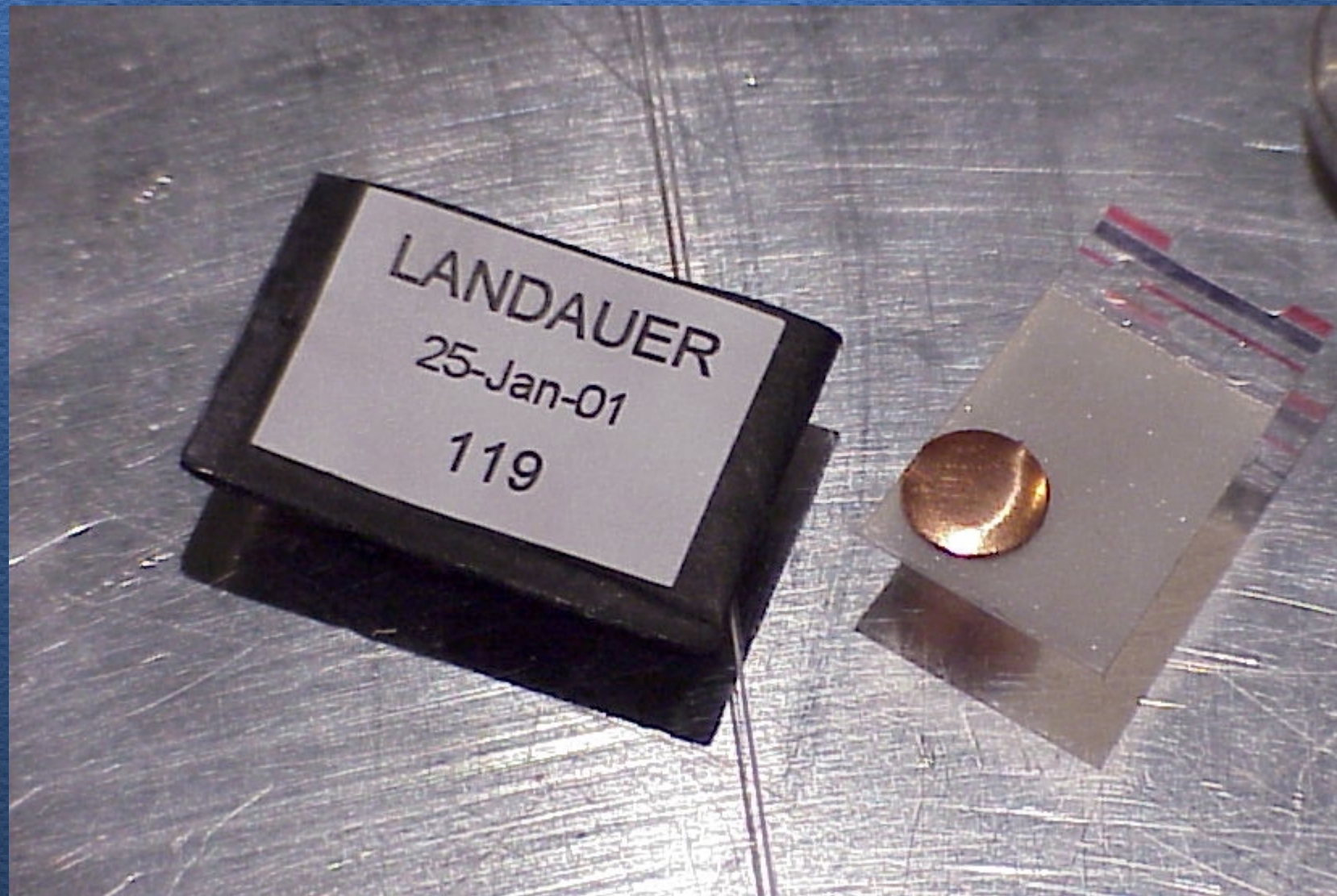

Dosimeter on Test Tool



Luxel Dosimeter Response Chest Phantom @ 120 kVp

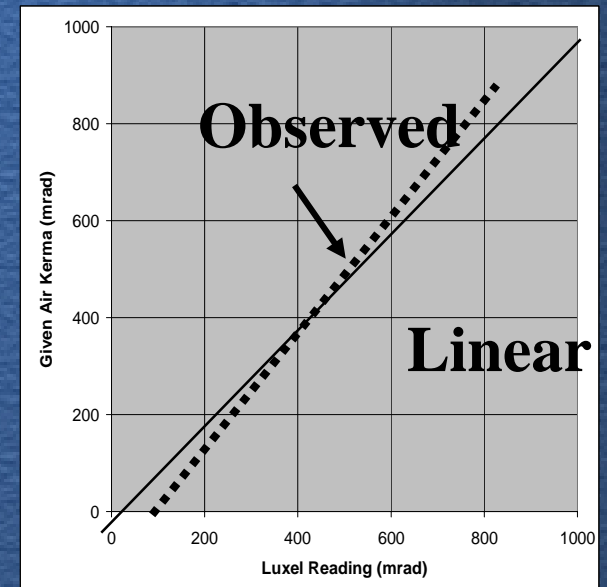
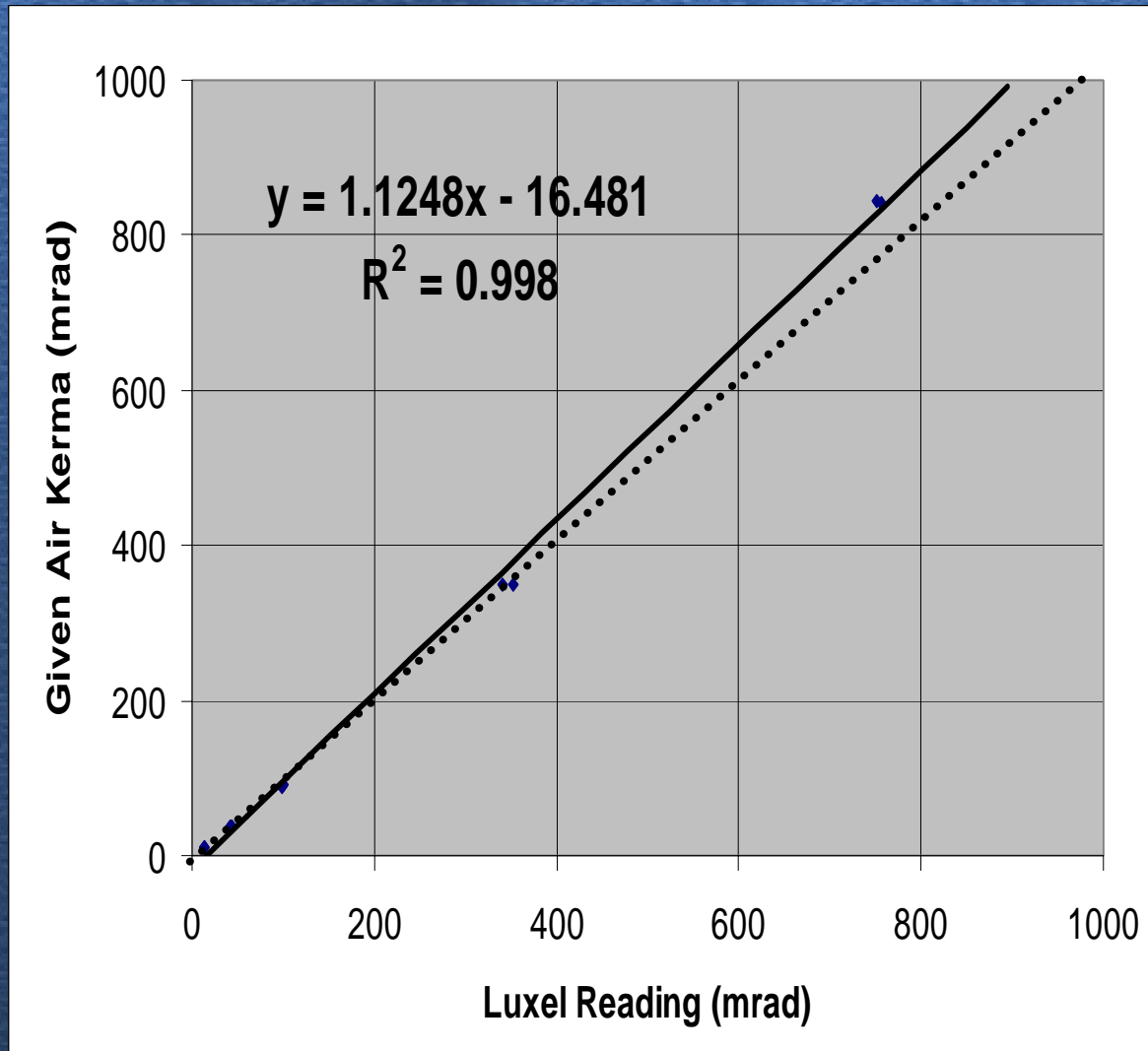

Luxel Accuracy vs Given Air Kerma Chest Phantom @ 120 kVp

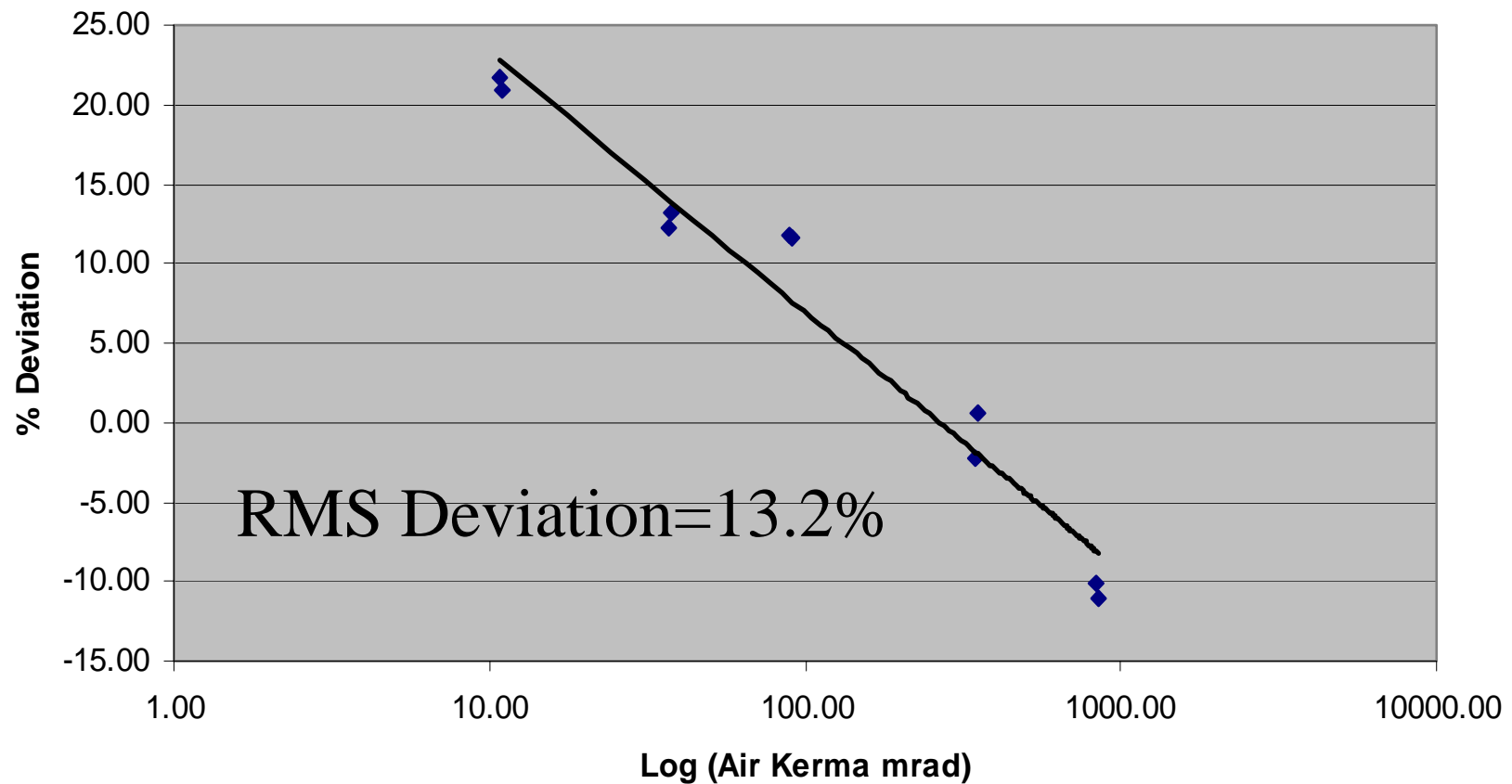

Given Air Kerma vs Luxel Reading Chest Phantom

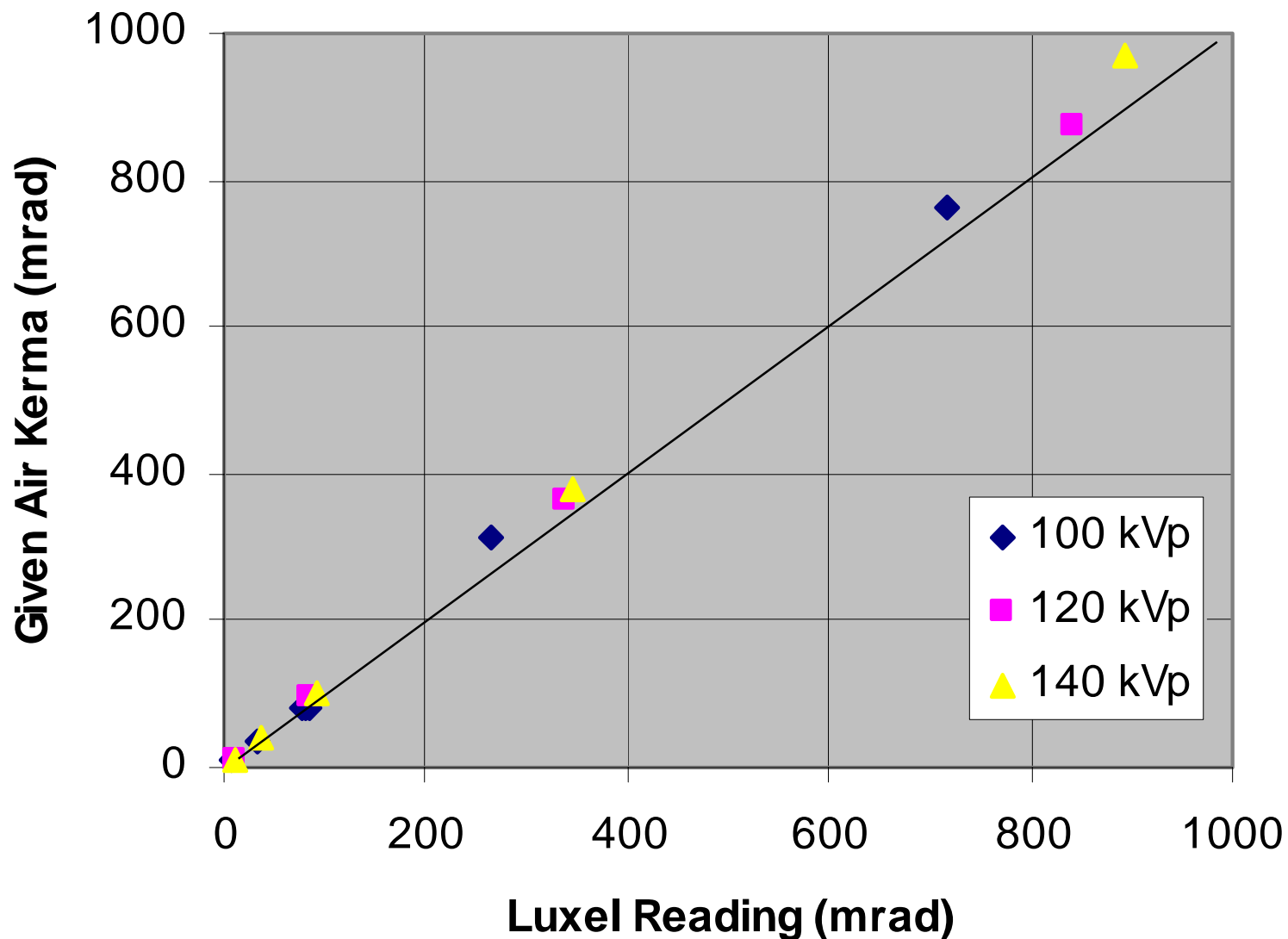

Luxel Dosimeter Response Abdomen Phantom @80 kVp

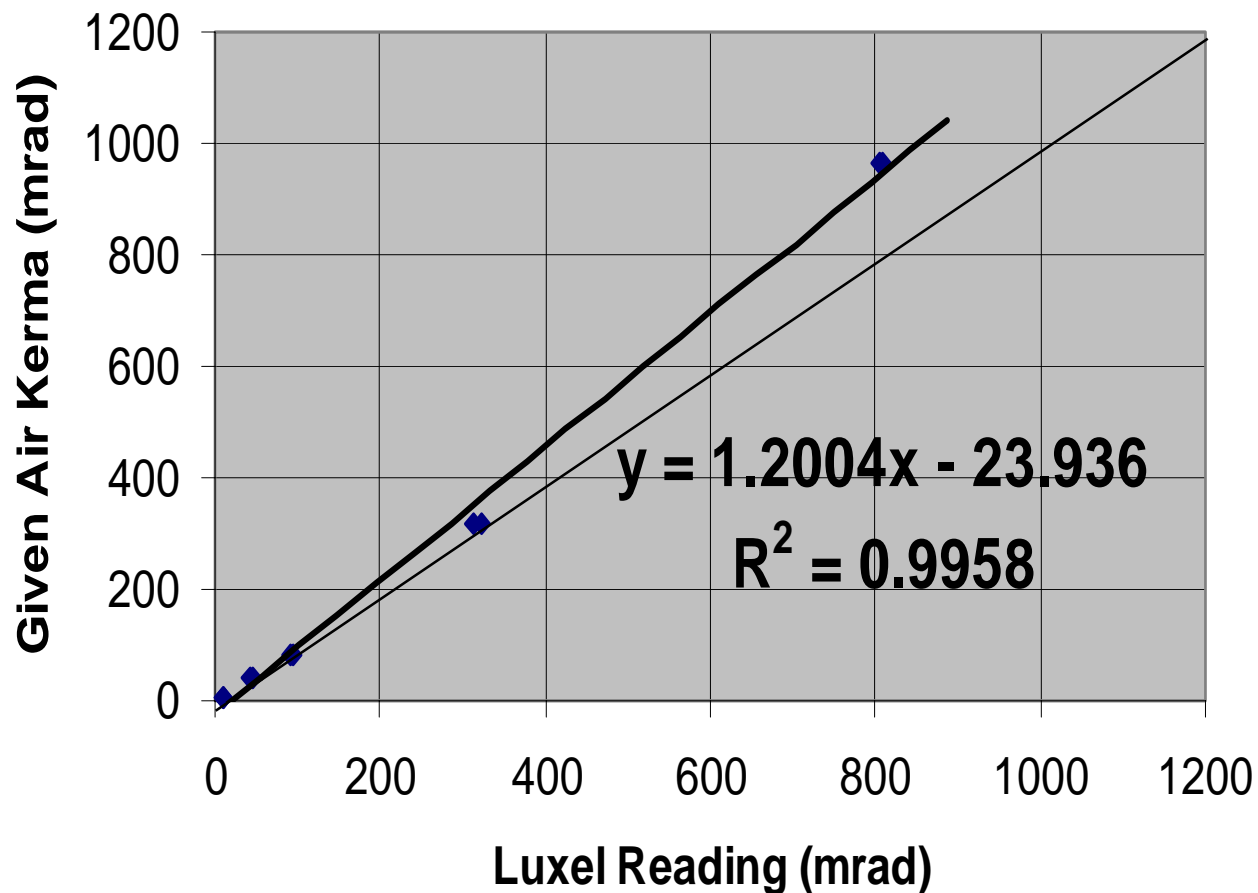

Dosimeter Precision

- Two sets of 6 dosimeters were irradiated using 100 and 120 kVp beams. Dosimeters on top of phantom.
 - 100 kVp (6): 81.0 +/- 2.6 mrad (3.2 %)
 - 120 kVp (6): 36.4 +/- 1.5 mrad (4.2%)
- Pairs of dosimeters were irradiated at air kermas of ~ 9, 36, 90, 360 and 900 mGy using 80 and 120 kVp beams.

RMS Differences

- 80 kVp (5 pairs): 3.5%
- 120 kVp (5 pairs): 2.0%

Selection of Phantom Manufacturer

- RFP sent to potential manufacturers
 - RFP contained detailed specifications
 - Materials
 - Phantom and test object dimensions and tolerances
 - i.e. hole depth for low contrast object: $0.068'' \pm 0.0005''$
- Manufacturers submitted three phantoms for testing

Manufacturers' Response to RFP

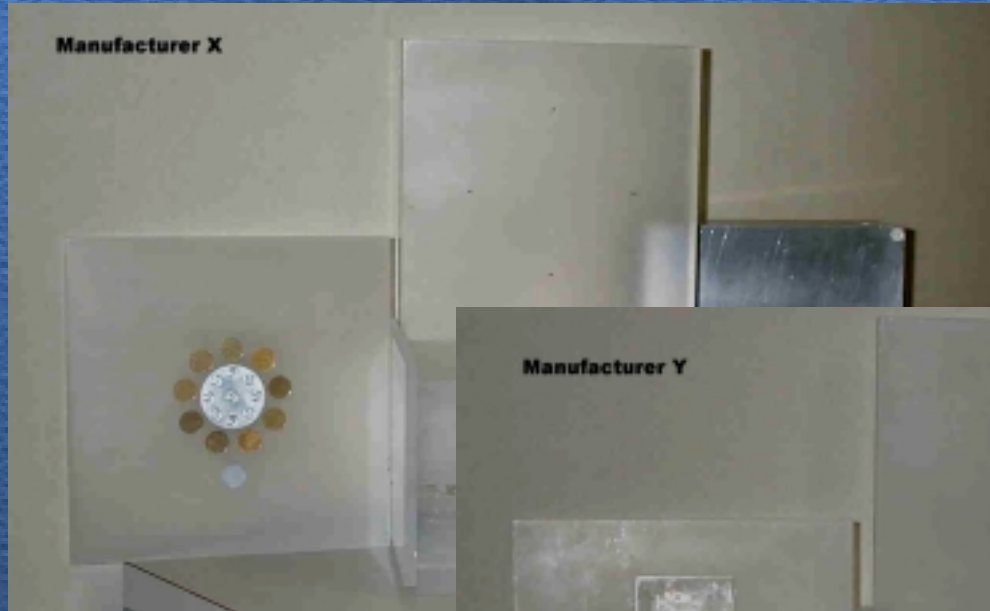

Selection of Phantom Manufacturer

- Phantoms evaluated by an independent medical physicist
 - IMP chosen on basis of qualifications
 - Availability of appropriate test equipment
 - Quality of IMP evaluation of three prototype phantoms constructed by ACR
- Committee's choice of manufacture based on IMP's tests of the manufacturer's pre-production phantoms

Hole Depths in Central Aluminum Disk

Average Difference (Specified - Actual)

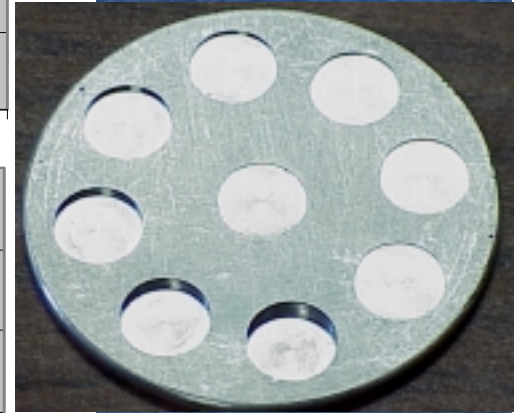
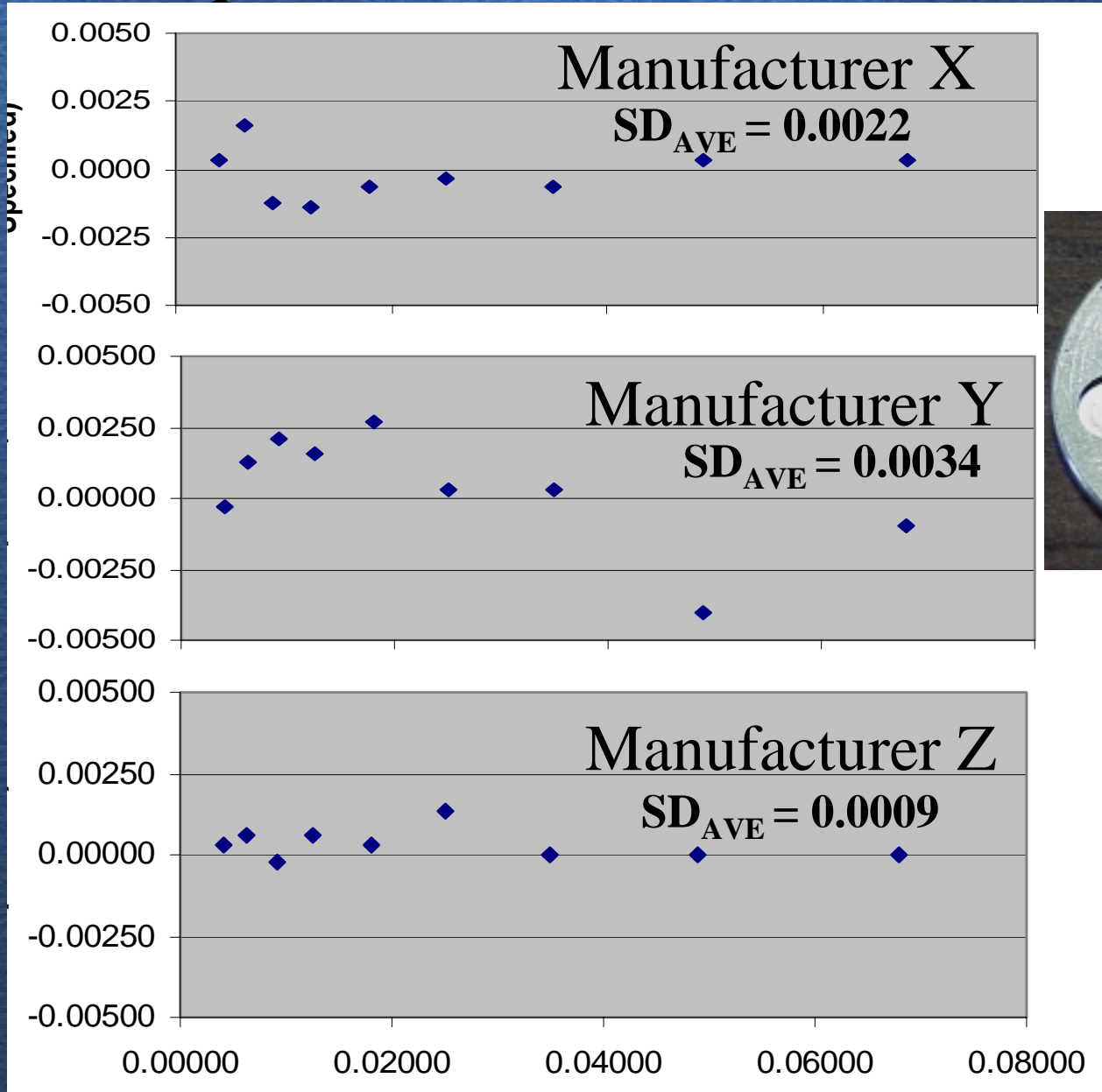

Pilot Accreditation Program Initial Phantom Data

- 9 facilities participated in pilot accreditation program
 - Low Contrast Detail Objects
 - Entrance Air Kerma

Contrast Detail Evolution Chest Phantom



3 physicists somewhat independently scored images

- Excellent agreement for 7 of 9 films
 - 6 passed and 1 failed
 - 2 disagreements

Entrance Skin Exposures Pilot Program

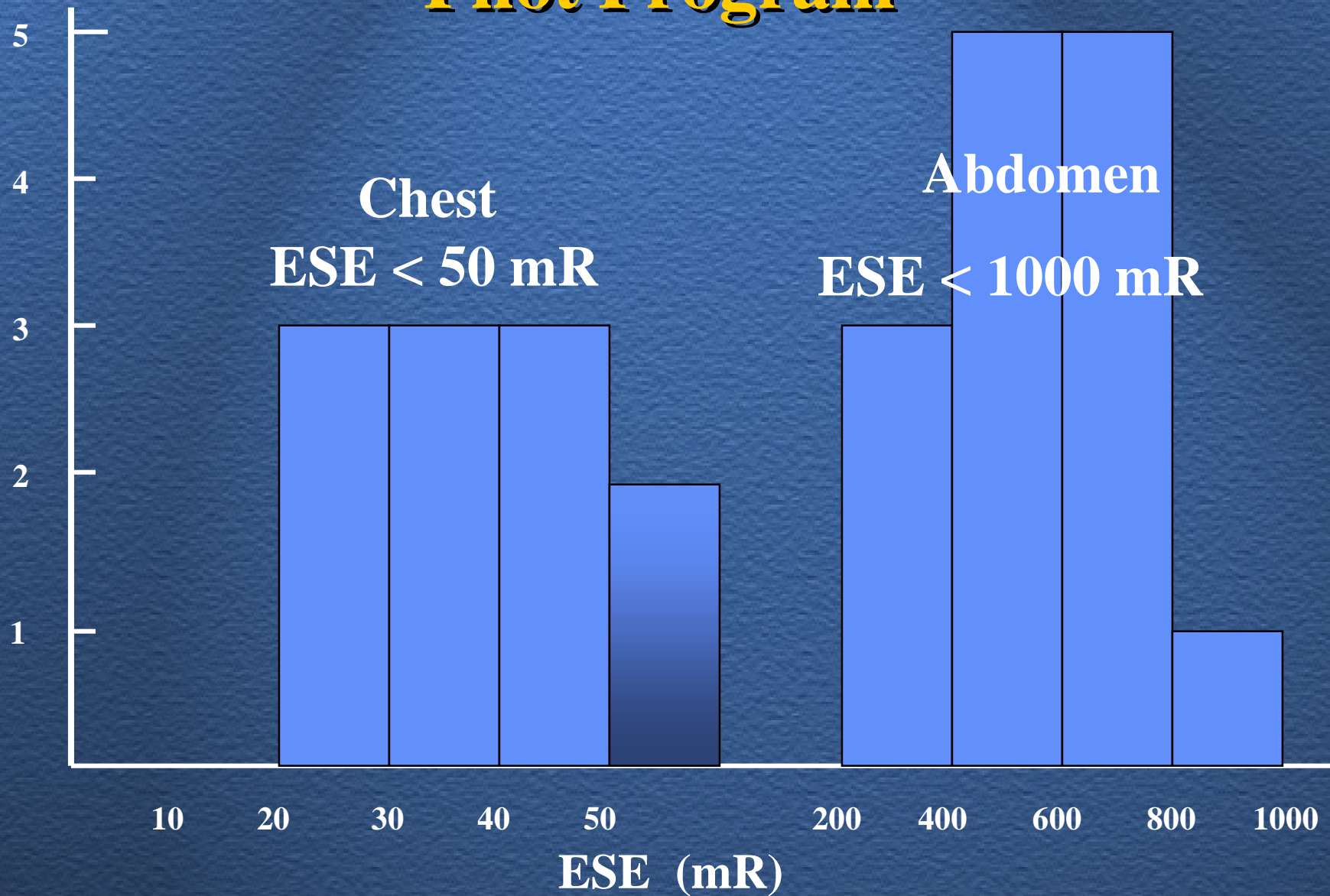

Initial Experience With Abdomen Phantom

- Incorporated phantom into annual equipment checks
- Data collection form is an Excel spreadsheet
 - Automatically performs linear regression of kVp vs mR/mAs
 - Computes ESE for abdomen and chest phantoms from kVp and mAs used
- Outliers are easily seen

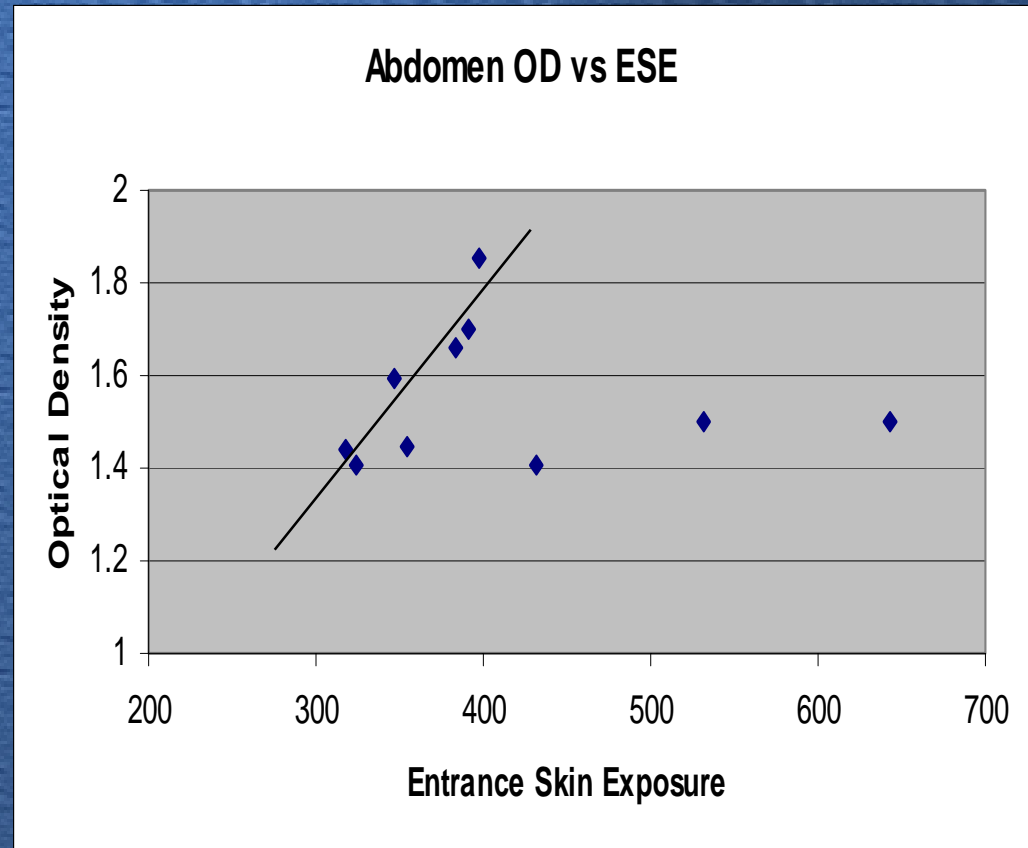

**All things come to an end.
Thank you.**

